

## **Pailo**

Focusing on  
the bigger picture,  
“...Pailo’s beauty  
goes much deeper  
than its surface...”

It’s a desking system  
designed around the way  
we want to work and how  
we use the space.

**SENATOR**

# BRINGING WORK HOME

## Pailo by Senator

As we continually move towards the desire for a more domestic working environment, Pailo provides a softer approach to the more formal bench desking systems that explores new ways to introduce new material combinations into the workplace. A natural selection for any corporate space the Pailo range incorporates a collection of single and back to back desks as well as multiple project tables to suit both formal and informal working styles.

Focusing on the bigger picture, Pailo is a desking system designed around the way we want to work and how we use the space. To offer customisable areas to suit even the most transient of workspaces, the inclusion of a gantry provides a hanging space for Pailo's versatile range of screens and accessories.











1

PAILO'S ADAPTABILITY ALLOWS USERS TO CUSTOMISE THEIR WORKSTATION. OFFERING A CHOICE BETWEEN THREE DIFFERENT SCREEN TYPES, MULTIPLE ACCESSORIES AND A VARIETY OF FABRICS FINISHES.

## IN THE DETAIL

Pailo brings together several material elements to create a more domestically styled product. Wood, metal, fabric and leather are forged together. The solid ash used on the legs and gantry was chosen for the beauty of the grain and can be specified with a matt clear finish or black colour wash, perfectly complimented by the neutral tones of the bridle leather straps used to suspend the hanging screens and cable baskets.

2

ALONG WITH THE VERSATILE SCREENS OF PAILO THE DESK SURFACES COME IN A RANGE OF FINISHES, BLACK, WHITE, NATURAL AND EVEN THE OPTION TO ADD PREMIUM FENIX DESKTOP.



3

THE DEPTH OF DETAIL IN THIS DESIGN IS THE FUNDAMENTAL DIFFERENCE THAT ELEVATES PALIO FROM OTHER TRADITIONAL DESKING SYSTEMS ON THE MARKET.











1

HANGING SCREENS CAN BE SUSPENDED FROM THE GANTRY BY BRIDLE LEATHER STRAPS, LEAVING THE ABOVE SPACE FREE TO BE USED FOR PENDULOUS LIGHTING AND PLANTS.

## ADAPTABLE SOLUTIONS

Define boundaries, add privacy, encourage collaboration – it's up to you.

Pailo's collection of customisable elements makes the system adaptable to the activity, formal or informal. It allows people to share knowledge and ideas quickly and effectively in a way that suits their communication and learning styles.

2

PAILO'S CLOUD SCREENS CREATE A PLACE TO PIN IDEAS OR NOTES TO REMEMBER, MOUNTING DIRECTLY TO THE UNDER STRUCTURE OF THE DESK TO GIVE THE ILLUSION THAT THEY ARE FREE FLOATING.



3

PAILO'S ADJUSTABLE DRAPE SCREENS OFFER PERSONALISED LEVELS OF PRIVACY, ATTACHED TO THE GANTRY THEY CAN BE RAISED OR LOWERED BY THE USER TO SUIT INDIVIDUAL PREFERENCE.













1

PAILO'S SPECIALLY DESIGNED FRAME ENSURES CABLES CAN BE EFFORTLESSLY MANAGED AND ALLOWS POWER TO BE INTEGRATED SEAMLESSLY.



2

NO DETAIL IS AN AFTERTHOUGHT. PAILO PERFECTLY POSITIONS USER PREFERENCES AT THE HEART OF ITS DESIGN.



3

THE SLEEK AND INNOVATIVE COMPOSITION OF PAILO'S DESIGN ENSURES THAT ITS AESTHETICS ARE NEVER COMPROMISED.



## UNDERSTATED INNOVATION

Pailo's beauty is more than surface deep, although constructed from wood, Pailo's legs are securely held in place via a metal to metal connection. The casting continuously connects to Pailo's innovative extruded beam structure, featuring a groove that hides all fixing points and also makes the underside smooth to the touch.



## COLLABORATE AND CONNECT

Mobile technology and personal devices have become an essential integration into work life. With optional built in power and data, Pailo project tables give careful deliberation to the correct ratio of connectivity points to user and cable management, increasing in proportion with table size to create a desirable destination - to think and recharge, to collaborate and connect.





## TECHNICAL SPECIFICATIONS FIXED TOP

### STANDARD FEATURES (\*SELECTED MODELS ONLY)

Solid Ash sculpted legs  
Tooled Aluminium components  
Hidden frame fixings  
Levelling feet  
Scalloped cable access  
25mm rectangular tops with table ends

### SPECIFIABLE FEATURES

In-line or back to back frames

### COMPLEMENTARY OPTIONS

Desk gantry for hanging lights and screens  
Adjustable drape screens  
Hanging screens  
Bench desk cloud screens  
Single desk cloud screens (integrated modesty panel)  
Suspended lighting  
In-desk power modules for project tables  
Heavy gauge wire baskets in accent colours  
Wire under-desk storage caddy

### PERFORMANCE STANDARDS

BSEN527, Part 1, 2011  
BSEN527, Part 2, 2002  
BSEN527, Part 3, 2013  
BSEN 6396 2008  
BSEN 9241 Part 5, 1999  
BSEN 15372 2008

### ACCESSORIES

Monitor arms  
PU desk accessories  
Desk top accessories  
CPU holders  
Electrical accessories

## DIMENSIONS

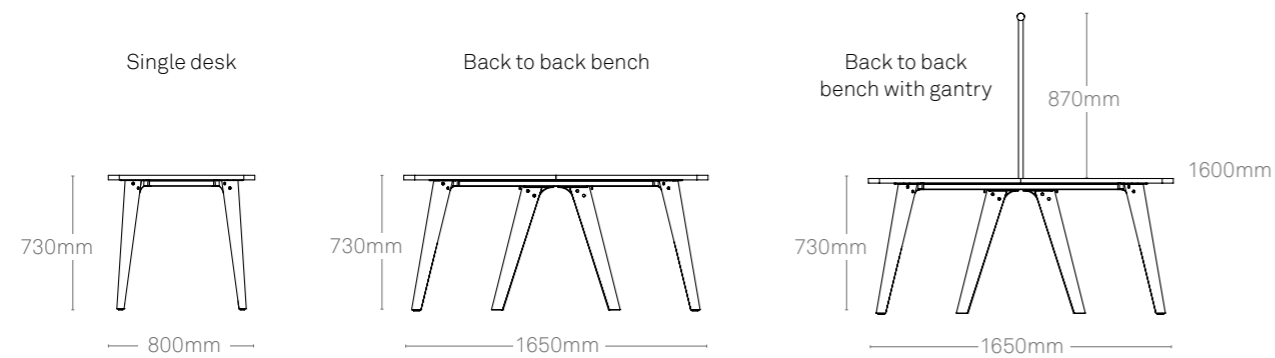

## TECHNICAL SPECIFICATIONS CONFIGURATIONS

### PAILO SINGLE DESK

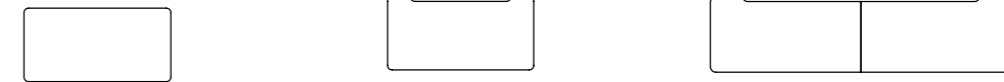

### SINGLE EXECUTIVE DESK

Widths. 1200–2000mm  
Depth. 800mm

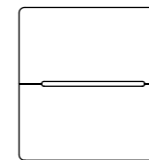

### STAND ALONE DESK

Widths. 1200–2000mm  
Depth. 800mm

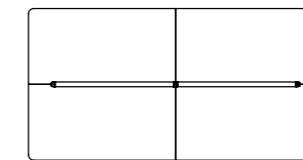

### IN-LINE DESK

Widths. 1200–2000mm  
Depth. 800mm

### 2 PERSON

Widths. 1200–2000mm  
Depth. 1650mm

### 4 PERSON

Widths. 1200–2000mm  
Depth. 1650mm

### PAILO PROJECT TABLE

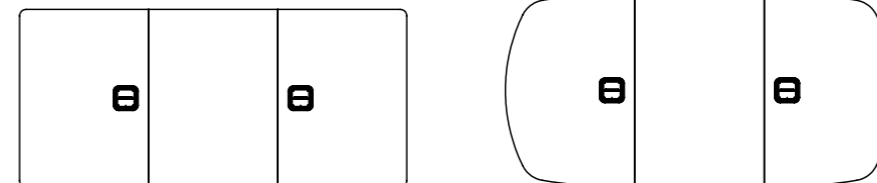

### PROJECT TABLE

Widths. 2400–4800mm  
Depth. 1650mm

### BOAT SHAPED PROJECT TABLE

Widths. 2400–4800mm  
Depth. 1800mm



## PAILO FINISHES

### Standard MFC Top Finishes



(TFL Edge 69 only)

### Contrast Edge Bands - For use on TFL (Edge 69) tops only

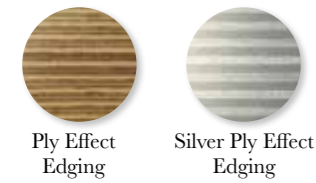

### Laminate S Finishes - Plywood core (Edge 33)\*



### Edge Finish - For use on Laminate (Edge 33) tops only



### Wood Leg & Gantry Finishes - Based on Ash



### Vertical Cable Riser Fabrics

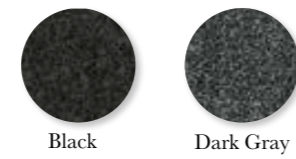

### Frame Finishes

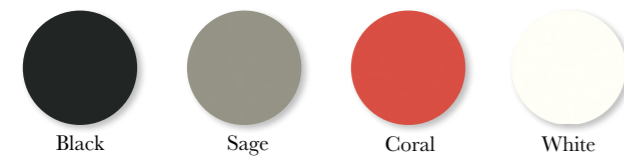

### Optional Accent Colours - For use on basket, cubby and gantry

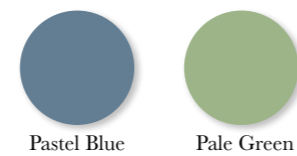

# Pailo

Part of The Senator Group

12.19 | Ed.2



Altham Business Park  
Sykeside Drive Accrington  
BB5 5YE

**THESENATORGROUP.COM**

**SENATOR**

12.19 | Edition 2