

INTRODUCING  
**Chemistry**

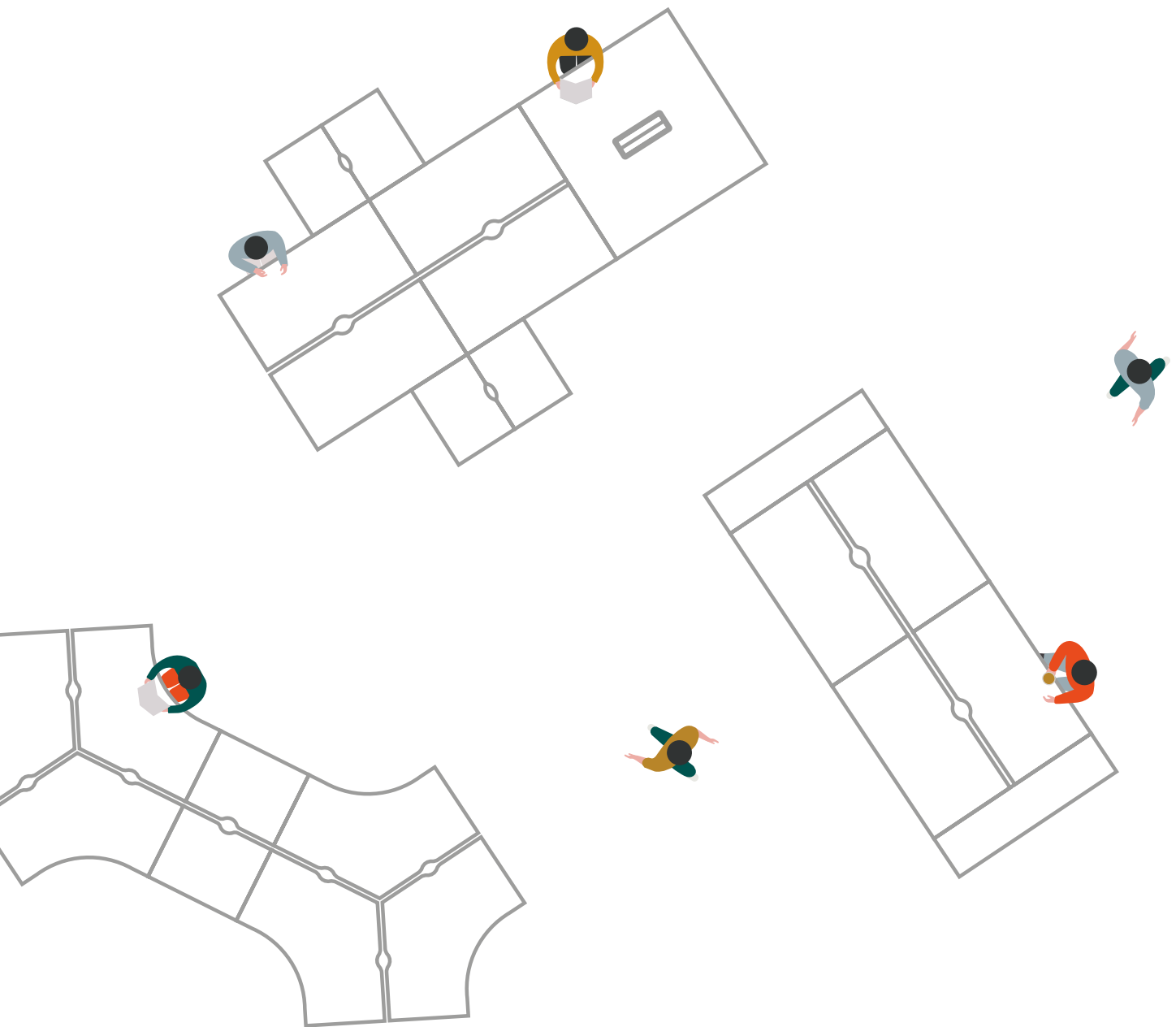

**SENATOR**

## A NEW ELEMENT TO AN EXISTING FORMULA

### Chemistry by Senator

As the modern workplace evolves, there is a declining demand for the 'one size fits all' approach. Instead, workplaces require spaces that are flexible and collaborative, facilities that are efficient and streamlined, combined with an atmosphere that can be both formal and informal.

The Chemistry range of workstations creates a stylish yet flexible solution that improves productivity and facilitates diversity for individuals and teams. Chemistry can be configured as individual desks or as a bench solution that shares components.

Available with fixed height tops or with a range of height adjustable options. The latest additions to the range bring team collaboration options in meeting table configurations whilst Canopy provides a more focused personal space.

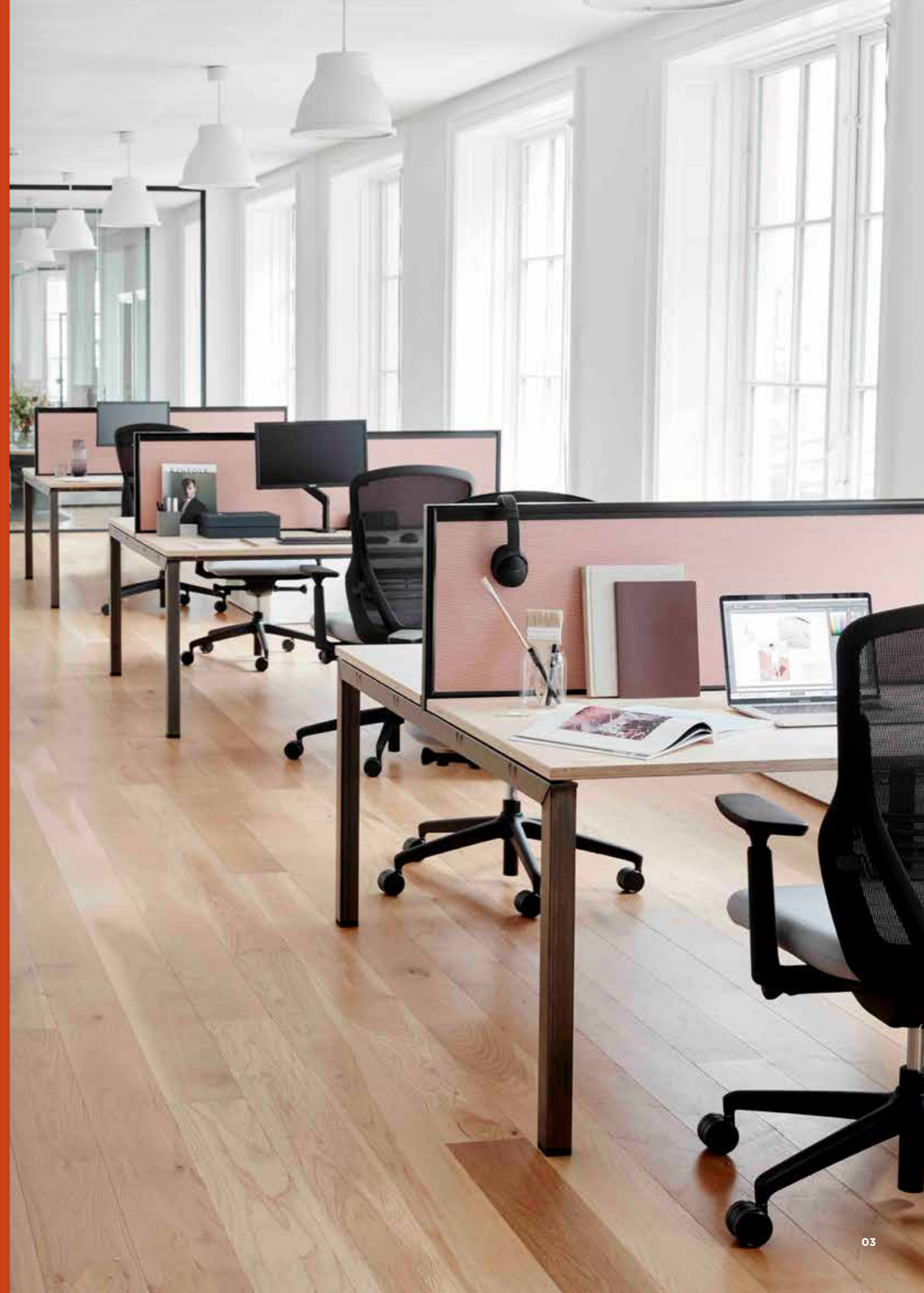



## **DEFINE YOUR SPACE**

Adding screens can define spaces and create zones within open plan offices and when mounted to the desk they enable personal privacy. They allow users to personalise their own space and improve desk organisation, Chemistry offers three distinct divider screen styles; - soft form pinnable fully upholstered panels, glass screens and aluminium trimmed upholstered panels that can incorporate tool rails for screen hung accessories.



## **AGILE DESIGN**

Carrying a consistent design element through a working environment brings positive effects to productivity levels. The synchronicity of the visual landscape actively encourages employees to adopt agile methods of working and use the space more effectively.





1

ADD RELAXED CURVES AND POPS OF COLOUR WITH OUR SOFT FRAMELESS SCREENS.

2

THE CALM AESTHETIC OF THE LEG CONCEALS A HOST OF INNOVATIVE FEATURES.

## REDEFINING BOUNDARIES

As we draw more on domestic influences within the corporate environment, we look to new ways we can influence the ambience of the space. Chemistry's collection of glass screens allow the creation of divisional spaces that benefit from the inclusion of natural light without eliminating the feeling of privacy and the acoustic benefits offered by fabric screens.



3

CHEMISTRY CANOPY CREATES AN INVITING WORK AREA THAT HAS THE CORRECT BALANCE OF PRIVACY, WITHOUT A FEELING OF ISOLATION.



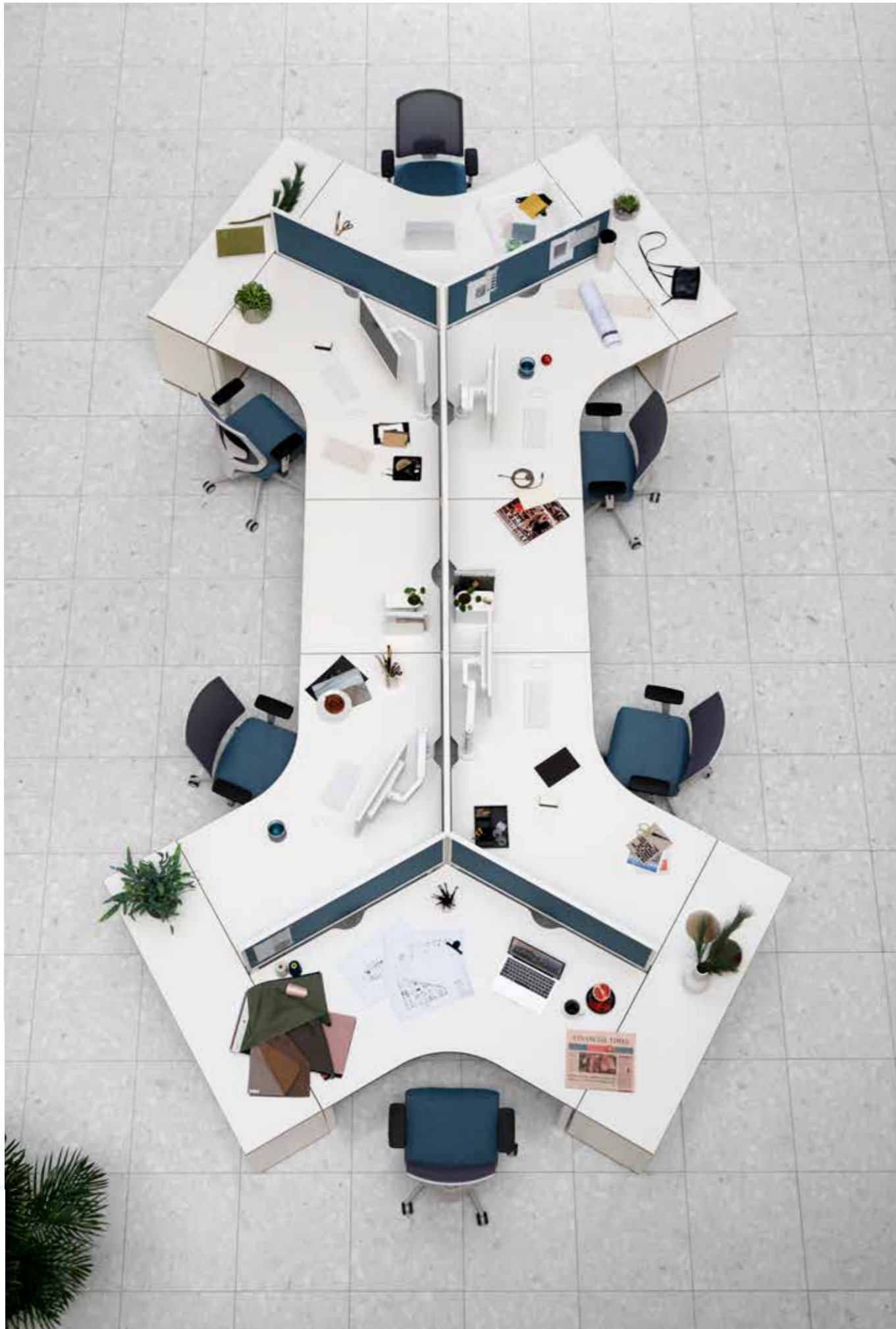

## COVERING ALL ANGLES

Chemistry's range of 120 degree desks are a smart solution perfect for small offices that are restricted by space but faced with the challenge of large teams thanks to the variety of cluster configurations. The natural curve of the desk offers the user a sense of enclosure perfect for individuals that prefer a sense of personal space. Clusters of 3 or more can be used to enhance collaboration by allowing colleagues to easily communicate.

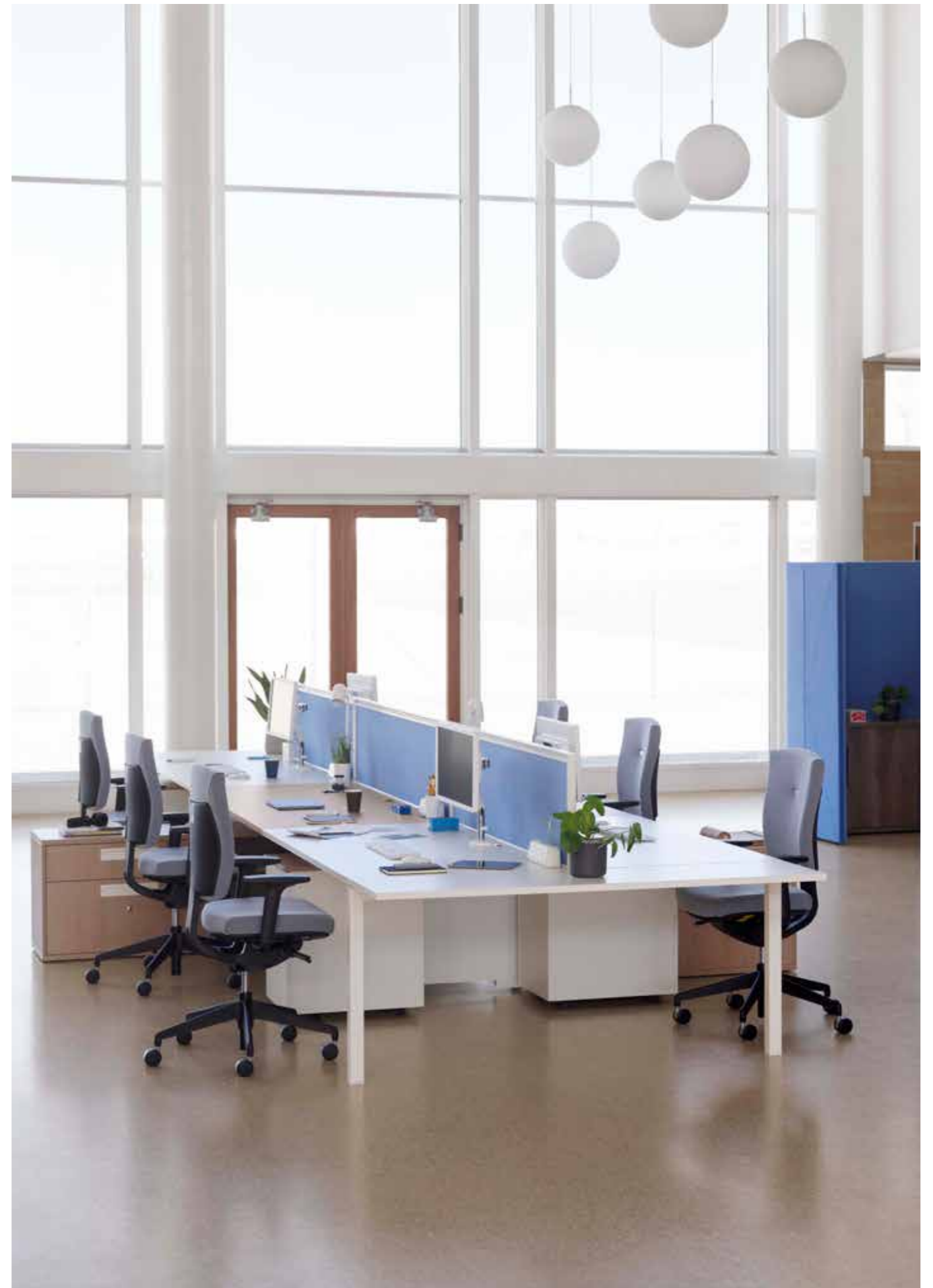



## SOLUTIONS

Chemistry offers a range of executive desks for spaces that require a managerial set up. Suitable for private offices or senior positions within open plan offices, Chemistry Executive desks feature built in lockable storage returns to keep information that may be of a sensitive nature close to hand. The storage units are available in two depths and offer built in cable management as standard that is discreetly hidden by a modesty panel.





### **REACHING NEW HEIGHTS**

Height adjustable desks have been widely recognized as an aid to employee wellbeing and productivity. Chemistry workstations are designed to fully interact with the user, whether that be seated or standing. Height adjustable desks permit the user to quickly set their optimum working height by means of a responsive push button electronic mechanism.

1

CHEMISTRY PRESENTS THE OPTION FOR CLIENTS TO ADD GLASS SCREENS, CREATING A MORE CONTEMPORARY STYLED DESKING SYSTEM.



2

DESK MOUNTED SCREENS ALLOW MULTIPLE CONFIGURATIONS TO BE JOINT TOGETHER AND REMAIN SEAMLESSLY CONNECTED.



3

MOUNTED DIRECTLY TO THE DESK UNDER STRUCTURE, CLOUD SCREENS OFFER A CUSTOMISABLE PLACE TO PIN IDEAS OR SAVE NOTES.



## FINISHES

When developing new ideas our creativity can easily be influenced by the surfaces, textures, and colors of our surrounding environment. As we design office spaces, we look to nature to inspire our material and finishes as we reach for a domestic feel in our professional environments.

With the demand for products to have this natural, softer aesthetic rises, our Chemistry range fulfills the need when specified with a natural plywood top with a raw metal frame.

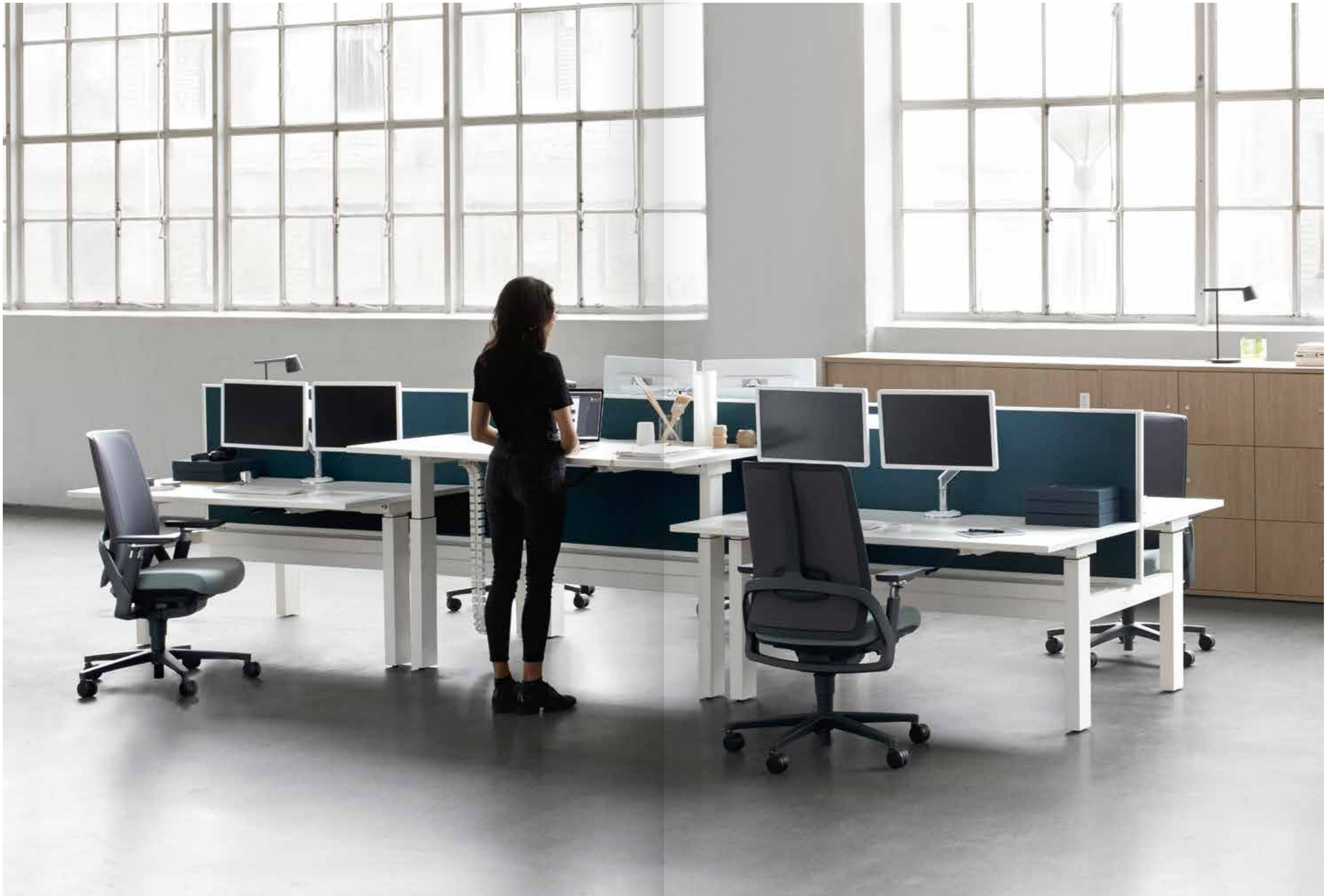

## TECHNICAL SPECIFICATIONS FIXED TOP

### STANDARD FEATURES (\*SELECTED MODELS ONLY)

50mm square steel tube legs with mitred corners  
7mm shadow gap between top and frame  
Universally sized steel dual crossrails  
Levelling feet  
Scalloped cable access  
25mm MFC rectangular tops or 25mm MFC 120° tops

### SPECIFIABLE FEATURES

Goal post leg  
In-line or back to back frames  
120° single or clusters (fixed only)

### PERFORMANCE STANDARDS

BSEN527, Part 1, 2011  
BSEN527, Part 2, 2002  
BSEN527, Part 3, 2013  
BSEN 6396 2008  
BSEN 9241 Part 5, 1999  
BSEN 15372 2008

### COMPLEMENTARY OPTIONS

Rectangular desk end meeting tops  
Desk end storage  
Rectangular returns  
Three screen types  
Height adjustable blocks for fixed desk  
Modesty panels  
Hinged cable trays  
Single cable riser, mid leg cable riser, and double cable risers

### ACCESSORIES

Monitor arms  
Desk top accessories  
CPU holders  
Electrical accessories

## DIMENSIONS

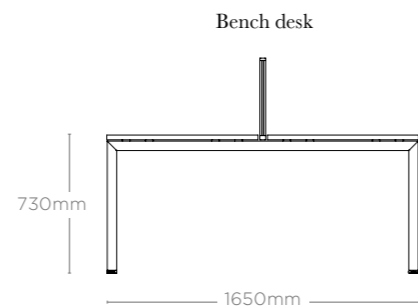
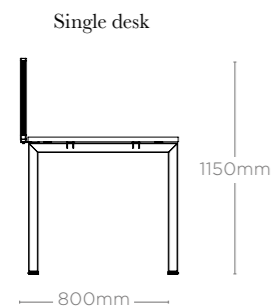

Goalpost

Single Height Adjustable

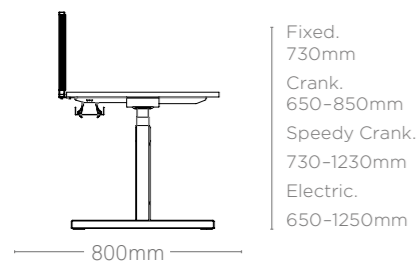

Fixed.  
730mm  
Crank.  
650-850mm  
Speedy Crank.  
730-1230mm  
Electric.  
650-1250mm

Back to Back Height Adjustable

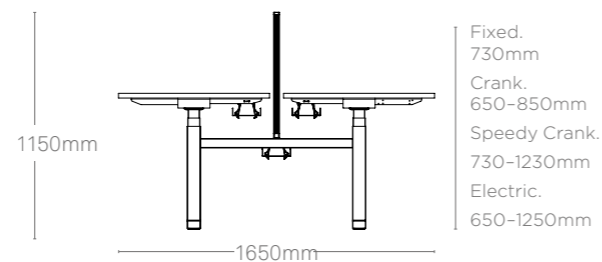

Fixed.  
730mm  
Crank.  
650-850mm  
Speedy Crank.  
730-1230mm  
Electric.  
650-1250mm

## TECHNICAL SPECIFICATIONS CONFIGURATIONS

### FIXED HEIGHT CONFIGURATIONS

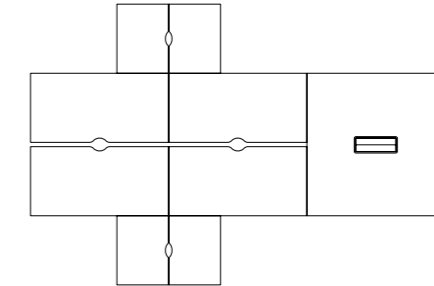
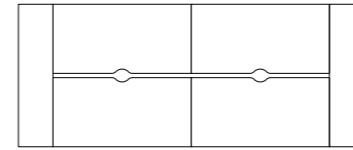

FOUR PERSON BACK TO BACK WORK STATION WITH DESK EXTENSIONS.

FOUR PERSON BACK TO BACK WORK STATION WITH DESK RETURNS AND MEETING TABLE.

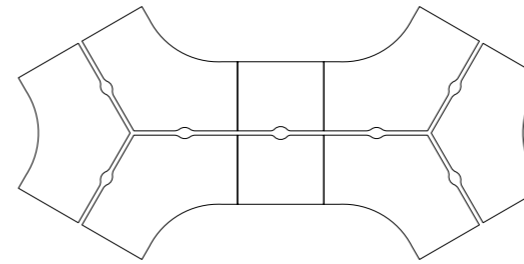

SIX PERSON BACK TO BACK 120° CLUSTER.

### HEIGHT ADJUSTABLE CONFIGURATIONS

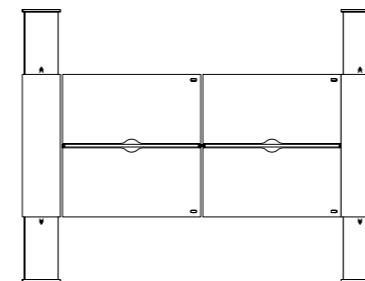

FOUR PERSON BACK TO BACK HEIGHT ADJUSTABLE WORK STATION WITH PULL OUT DESK END STORAGE.

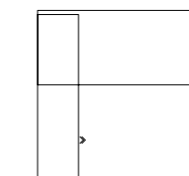

EXECUTIVE WORK STATION WITH INTEGRATED SIDE STORAGE.

## CHEMISTRY FINISHES

### Standard MFC Top Finishes



(MFC Edge 69 only)

### Contrast Edge Bands. For use on MFC (Edge 69) tops only.

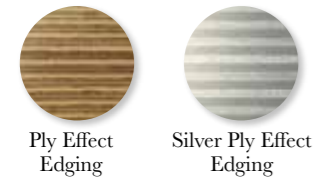

All MFC (Edge 69) tops come with a matching edge band as standard. Contrasting edge band can be specified.

Please contact customer service if you require a contrasting edge band.

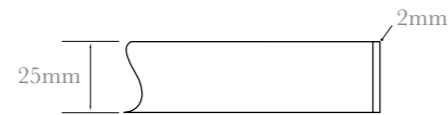

### Frame/Leg Finishes

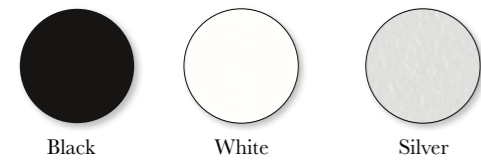

### Standard Screen Finishes - Acrylic

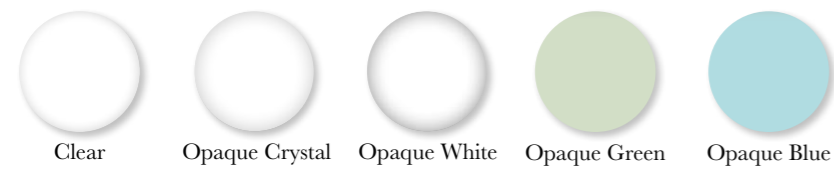

### Glass Screen Finishes



## SCREEN FABRICS

### Blazer Lite



### Cara



Colours on screen and in print may vary, order swatch sample before selecting a fabric finish.



# Chemistry

*Part of The Senator Group*

12.19 | Ed.2

Altham Business Park  
Sykeside Drive Accrington  
BB5 5YE

**THESENATORGROUP.COM**

**SENATOR**

12.19 | Edition 2